

GB

GB-ER SERIES (SR138R)

The GB-ER series combines original Magnescale technology and legendary durability with a built-in reference point.

- Excellent durability against workshop conditions - resistant to oil, dirt, shock and vibration.
- Compact design for a space-saving installation.
- Accuracy: $(5+5L/1000)\mu\text{m}$
- Resolution: $0.5\mu\text{m}$
- Simple structure should be conducive to long life.

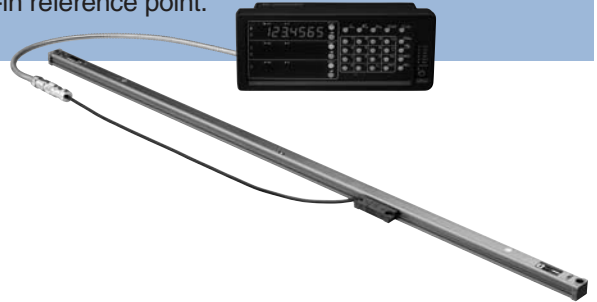

MAGNESCALE®

Dimensions

SR138R (Model name of the scale itself)

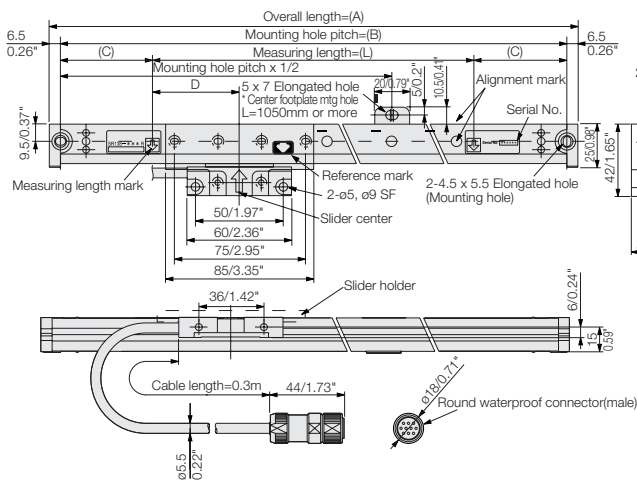

CH04 (Model name of accessory cable)

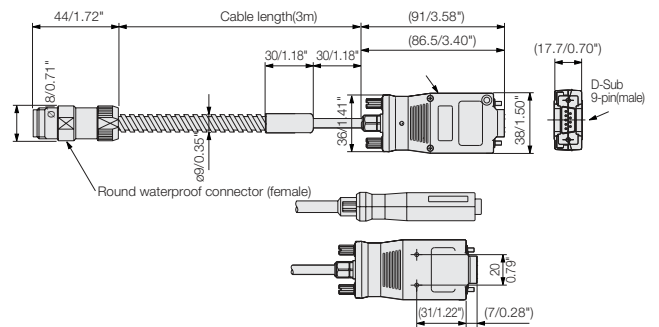

Unit : mm/inch

Specifications

Model		GB-ER
Effective length(L)		50/100/150/200/250/300/350/400/450/500/550/600/650/750/850/950/1050/1250/1400/1600/1850/2050/2200 mm
Scale length	Overall length(A)	L + 104mm (50 to 200mm) L + 120mm (250 to 2200mm)
	Max.travel	L + 14mm (50 to 200mm) L + 30mm (250 to 2200mm)
	With or without Centerfootplate	Without (50 to 950mm) With (1050 to 2200mm)
	Mounting hole pitch(B)	L + 91mm(50 to 200mm) L + 107mm (250 to 2200mm)
	(C)	45.5mm (50 to 200mm) 53.5mm (250 to 2200mm)
	(D)	L + 1/2 (50 to 250mm) 50mm (300 to 2200mm)
Accuracy at 20°C		$(5 + 5L / 1000) \mu\text{m}$
Reference point		Standard:Center point, User-selected point (AB quadrature)
Mounting parallelism		$\pm 0.1\text{mm}$
Expansion coefficient		$(11 \pm 1) \times 10^{-6} / ^\circ\text{C}$
Operating temperature		0 to 40°C
Storage temperature		-20 to 50°C
Head cable length		0.3m
Cable length		3m
Protective design grade		Scale:IP65 Interface unit:IP30
Input/Output signal	Output signal	AB/ quadrature signal, Z signal
	Power supply	DC + 5V $\pm 5\%$
	Connector	D-sub 9 pin
Resolution		0.5 μm
Response speed	Scale signal	60m/min
	Reference signal	60m/min
Power consumption		Max. 200mA

System configuration

Milling machine

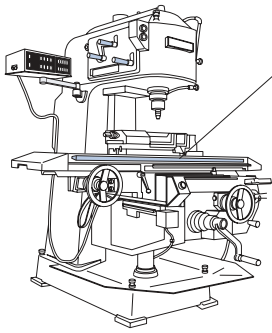

Scale unit GB-ER series

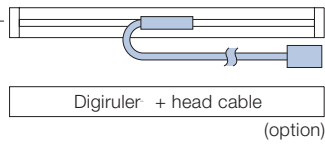

Counter LH70/71 series

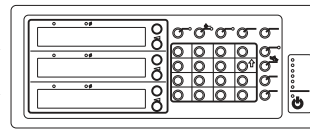

Extension cable (option) CE10-01C (1m)
 -03C (3m)
 -05C (5m)
 -10C (10m)

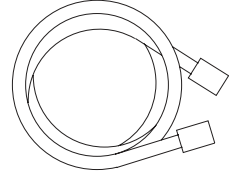

Lathe

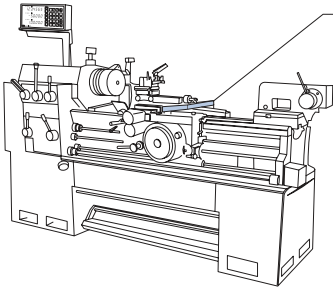

Scale unit GB-ER series

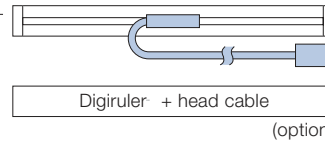

Counter LH70/71 series

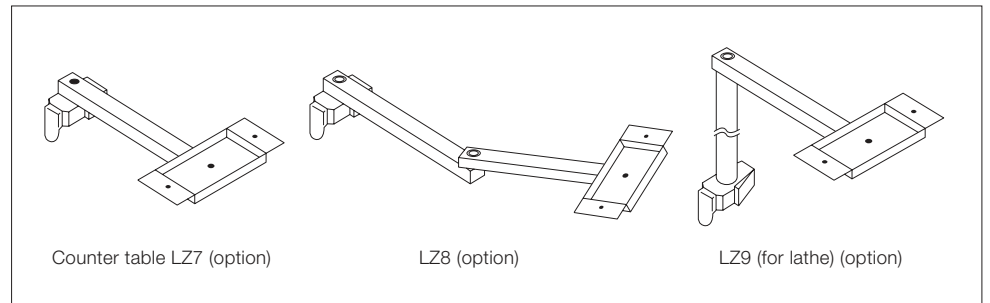
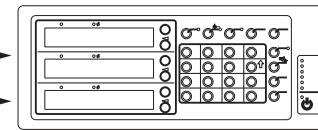

GB series connection example

